

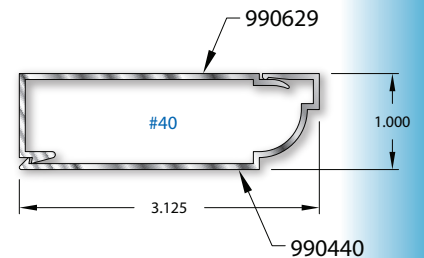

INTERIOR TRIM ASSEMBLY

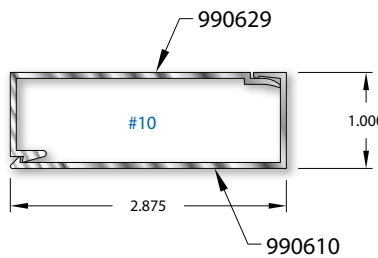
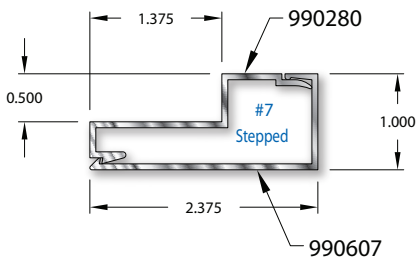
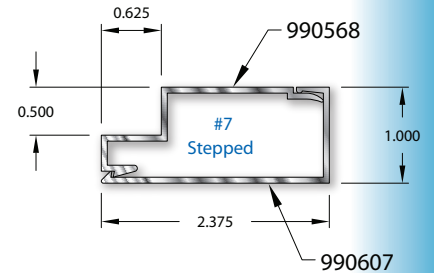
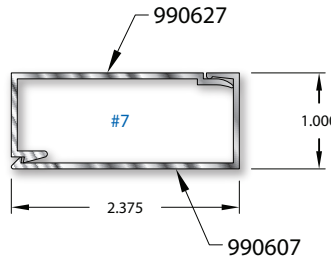
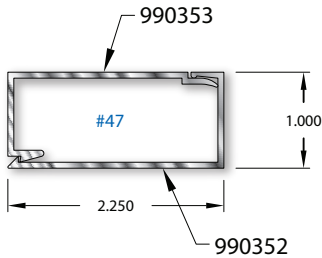
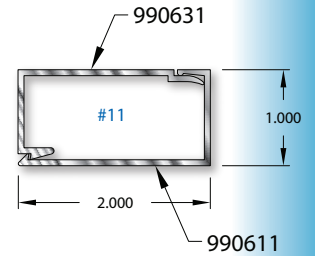
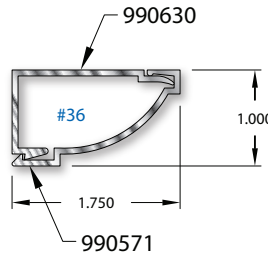
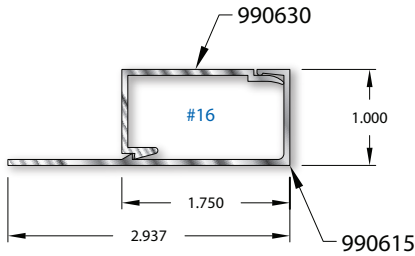
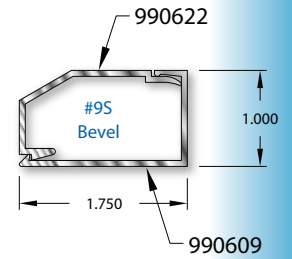
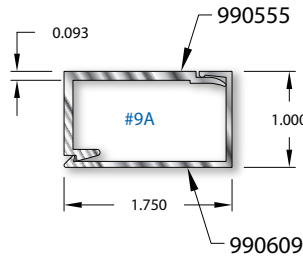
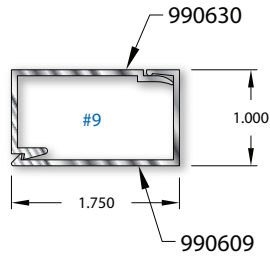
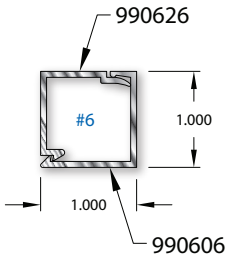
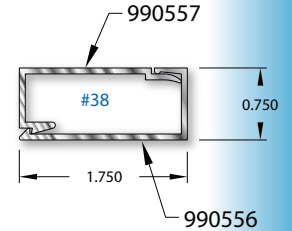
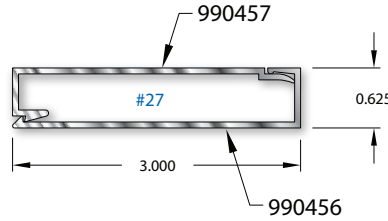
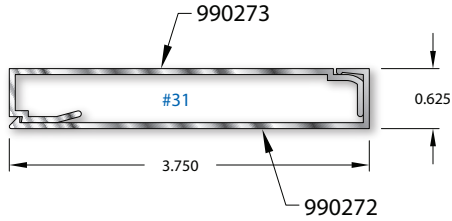

**All Available Accessory
Pieces Not Shown**

Details Are Not Shown to Scale

All available options not shown. For additional choices, please visit our website.

Check website for complete, current information including other installation and hardware options: www.grahamwindows.com

1551 Mt. Rose Avenue, York, Pennsylvania 17403-2909 • email: info@grahamwindows.com • (800) 755-6274 • 717-849-8100



INTERIOR TRIM ASSEMBLY

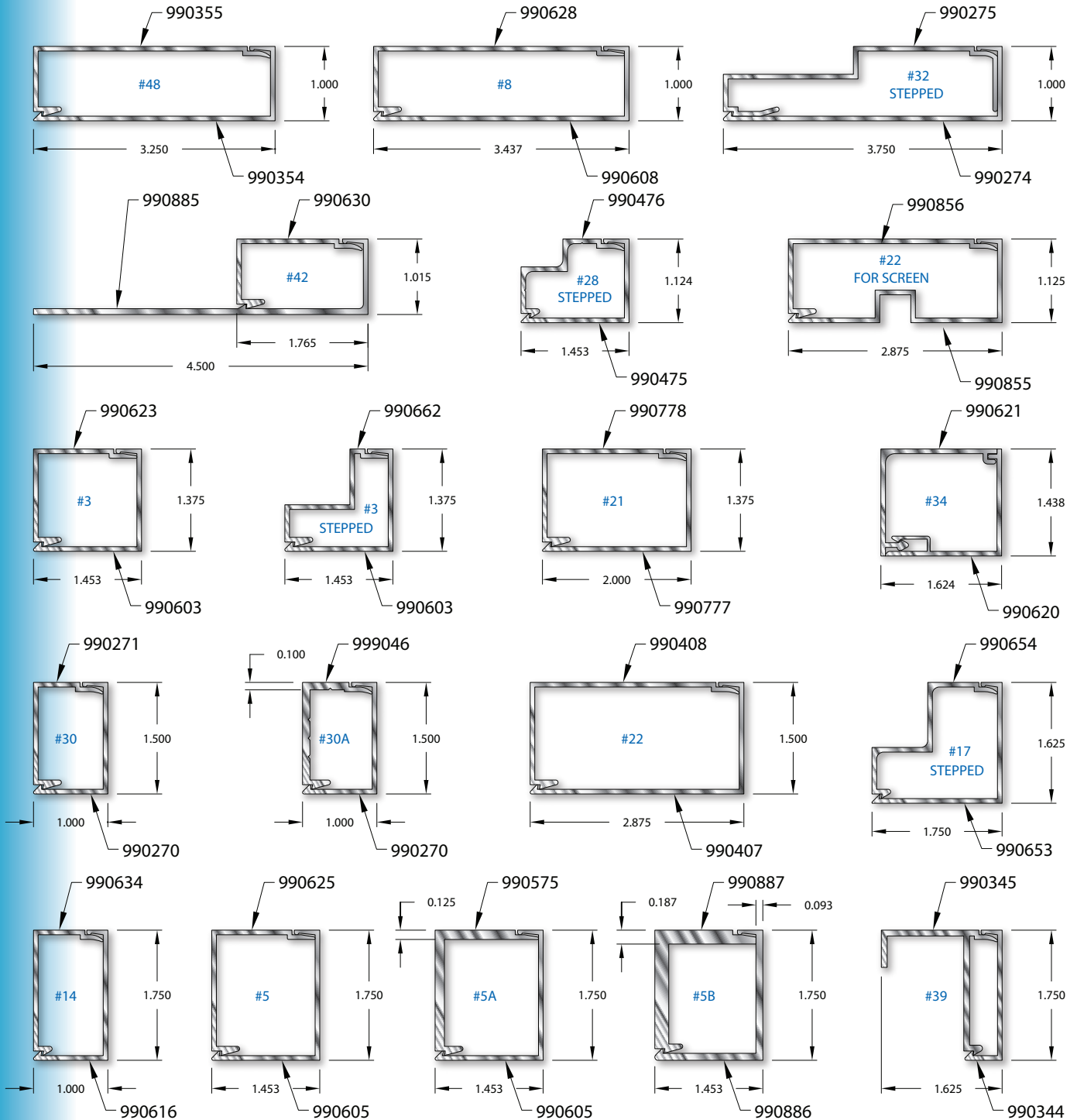

**All Available Accessory
Pieces Not Shown**

Details Are Not Shown to Scale

All available options not shown. For additional choices, please visit our website.

Check website for complete, current information including other installation and hardware options: www.grahamwindows.com

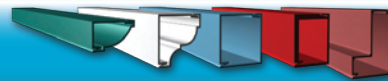

INTERIOR TRIM ASSEMBLY

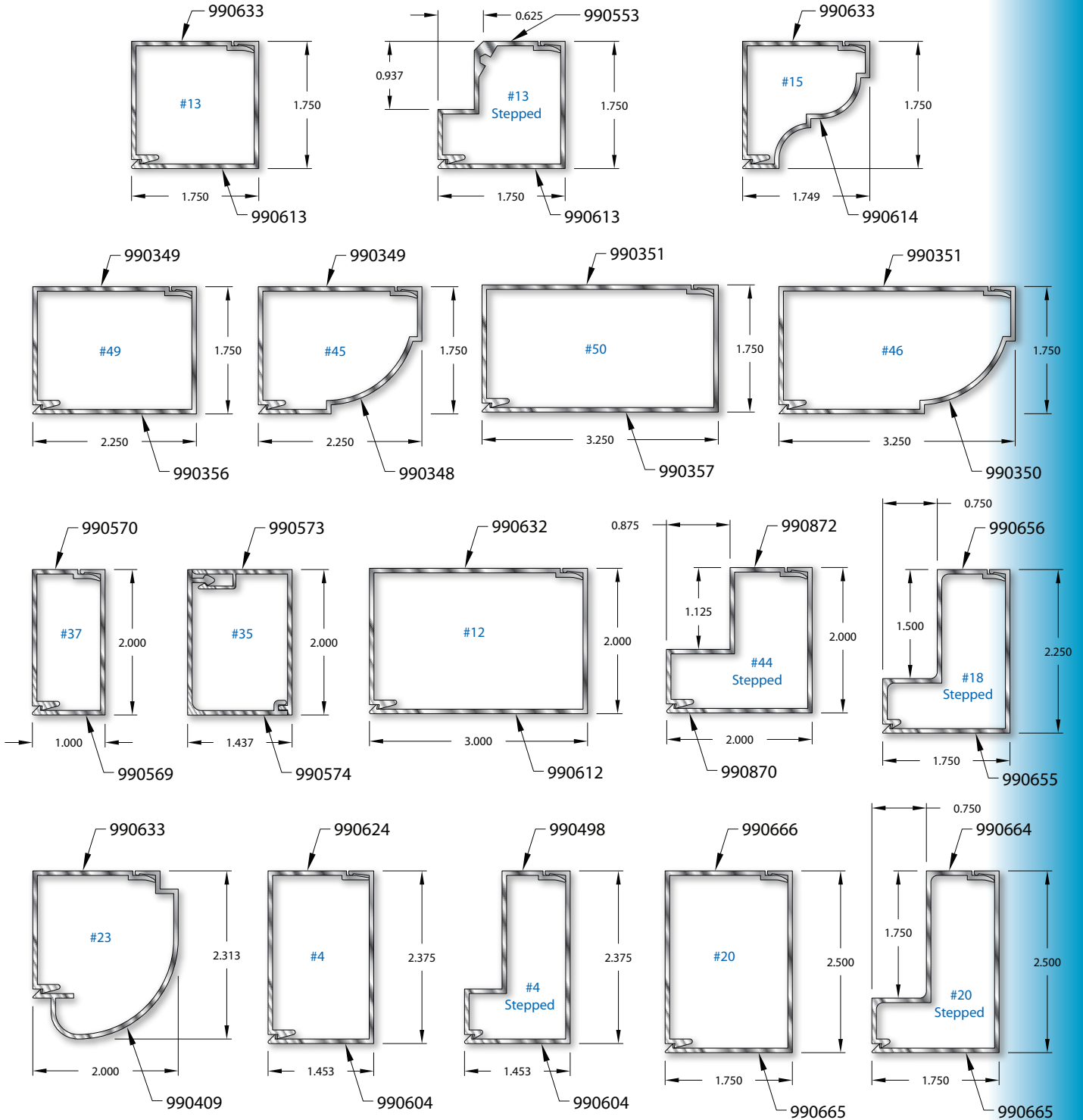

**All Available Accessory
Pieces Not Shown**

Details Are Not Shown to Scale

All available options not shown. For additional choices, please visit our website.

Check website for complete, current information including other installation and hardware options: www.grahamwindows.com

TRIM



INTERIOR TRIM ASSEMBLY

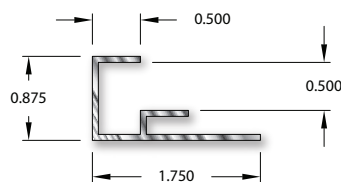
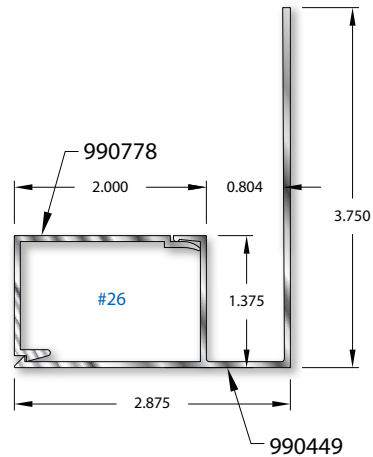
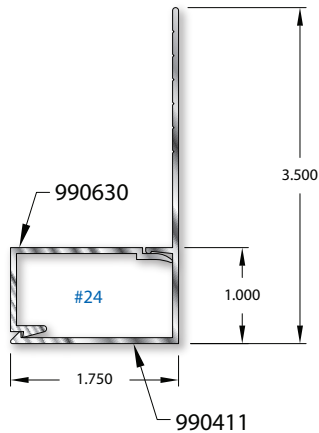
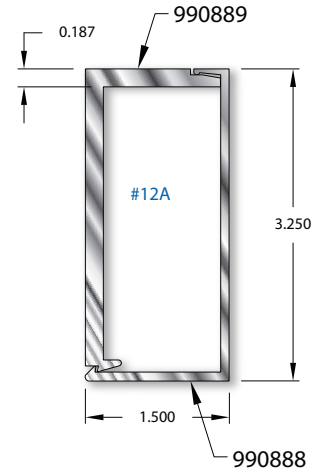
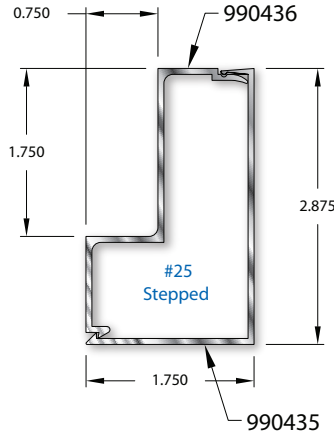
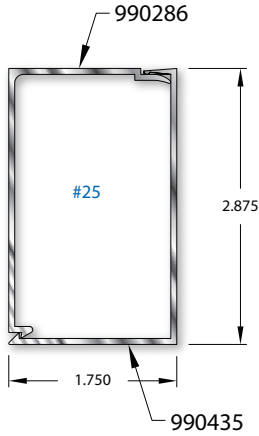

1/2" Drywall Trim
(No Clip)
999438

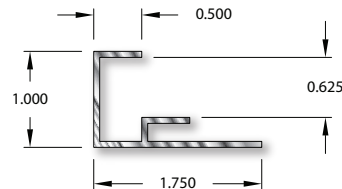

5/8" Drywall Trim
(No Clip)
999440

**All Available Accessory
Pieces Not Shown**

Details Are Not Shown to Scale

All available options not shown. For additional choices, please visit our website.

Check website for complete, current information including other installation and hardware options: www.grahamwindows.com

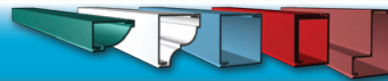

INTERIOR TRIM ASSEMBLY

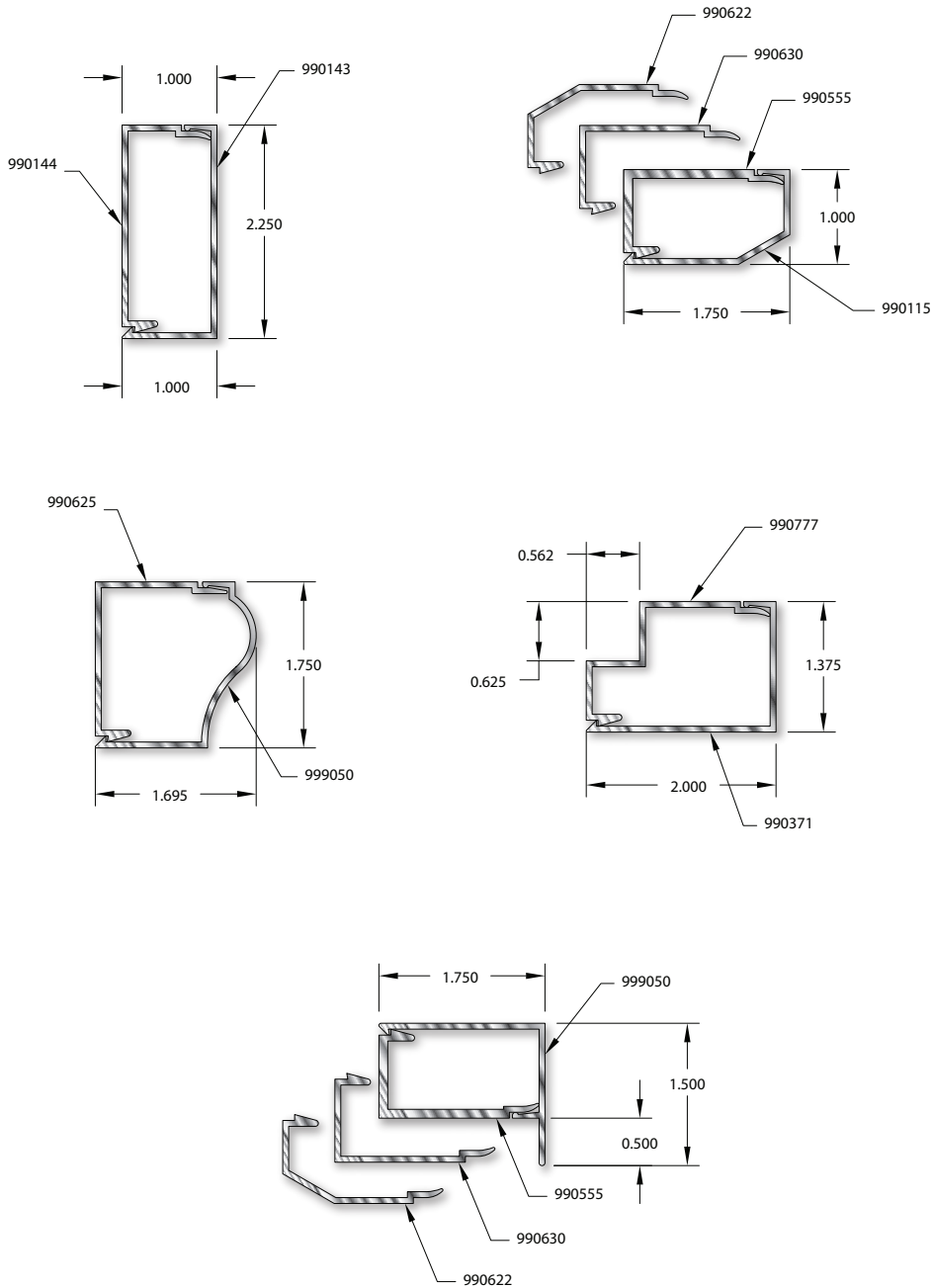

**All Available Accessory
Pieces Not Shown**

Details Are Not Shown to Scale

All available options not shown. For additional choices, please visit our website.

Check website for complete, current information including other installation and hardware options: www.grahamwindows.com

1551 Mt. Rose Avenue, York, Pennsylvania 17403-2909 • email: info@grahamwindows.com • (800) 755-6274 • 717-849-8100