

Graham

Terrace Door - 3 1/4"

HGD-HC50



Architectural Products

Series: S7400

Manufacturing Code: S7405

Drawing 5/16 Scale - For Custom Size Drawing Contact Graham

Note: Sealant Not Shown On Details. Consult Technical Services At Factory For Sealing Procedures.

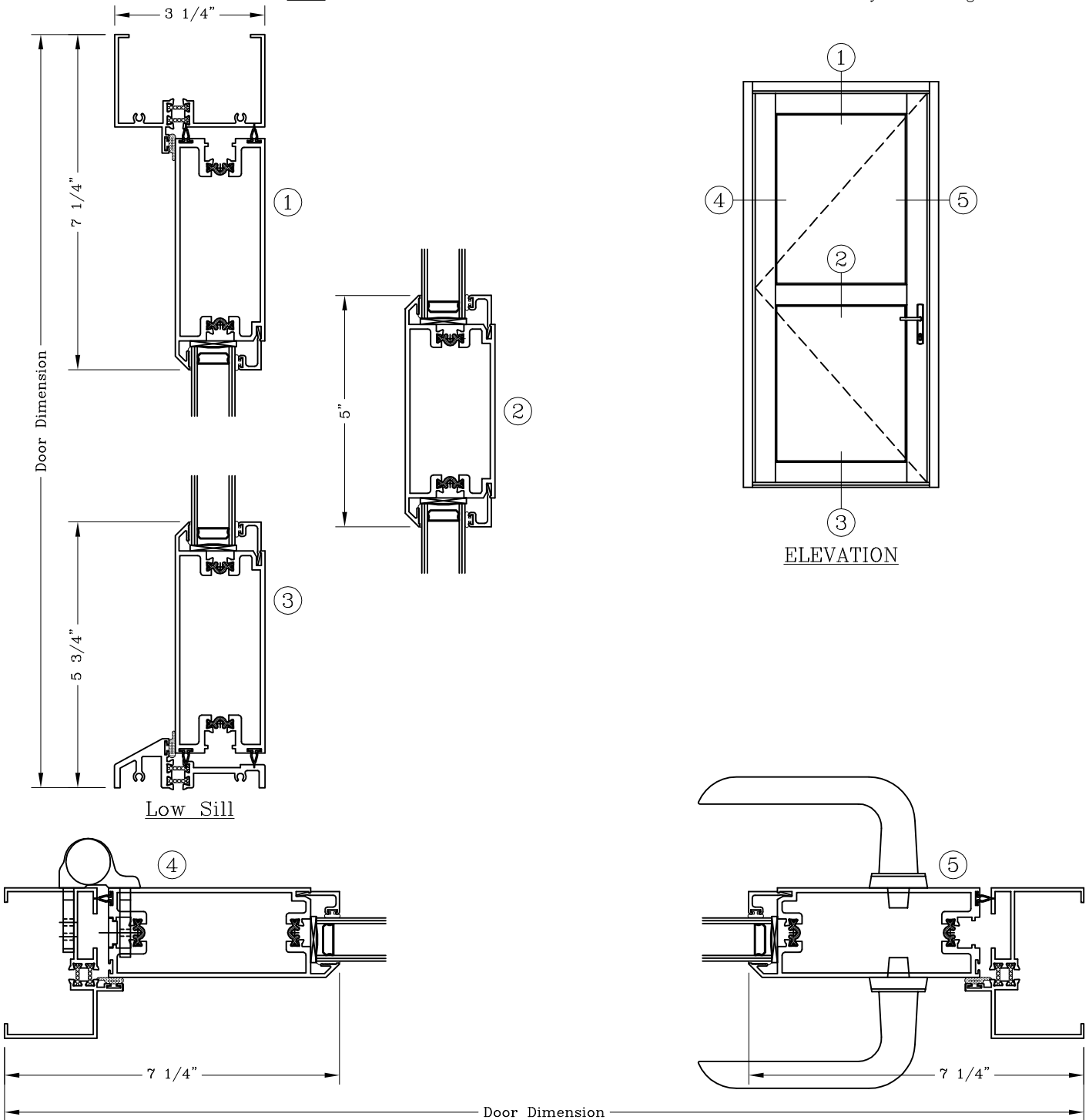

Note: Dashed Lines Represent Inswing Vented Units; Solid Lines Represent Outswing Vented Units; Lines Converge At Hinge Side Of Vent