

Graham

Casement/Casement - 4 1/2" C-HC100



Architectural Products

Series: 6900

Manufacturing Code: 6917

Drawing 1/2 Scale - For Custom Size Drawing Contact Graham

Note: Sealant Not Shown On Details. Consult Technical Services At Factory For Sealing Procedures.

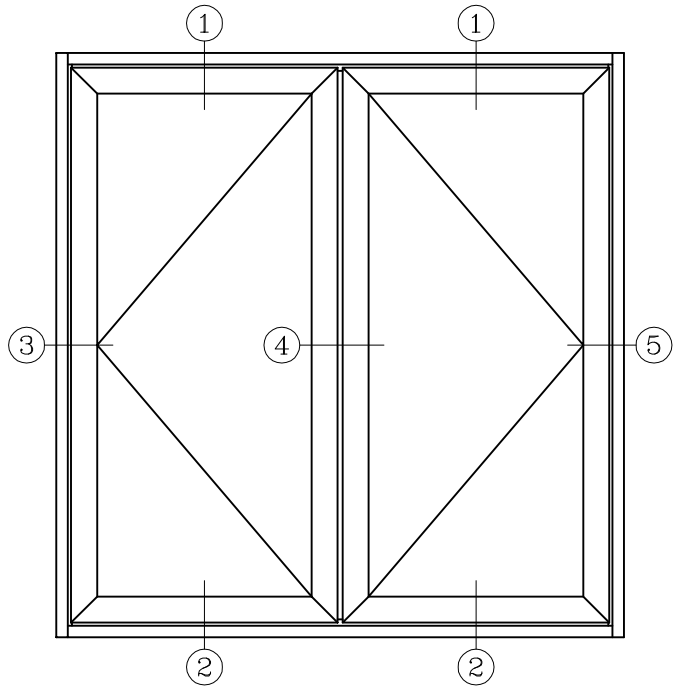
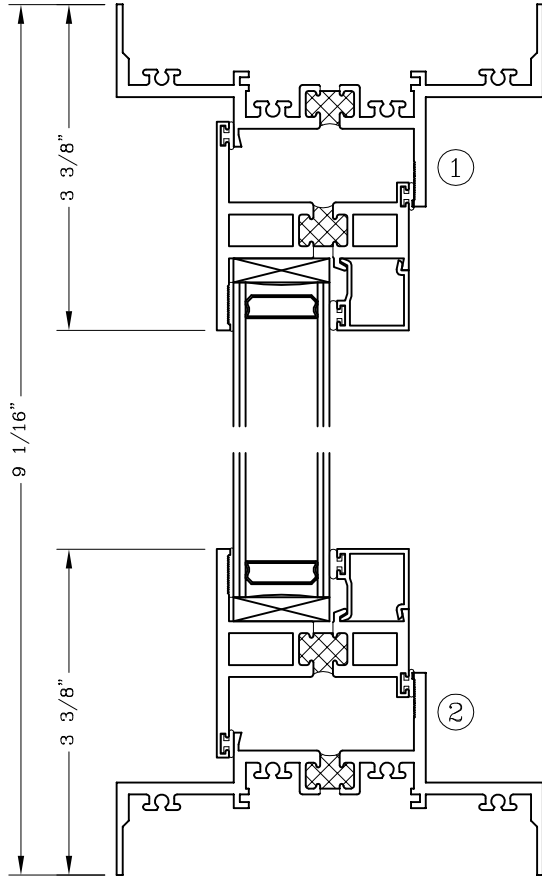

ELEVATION

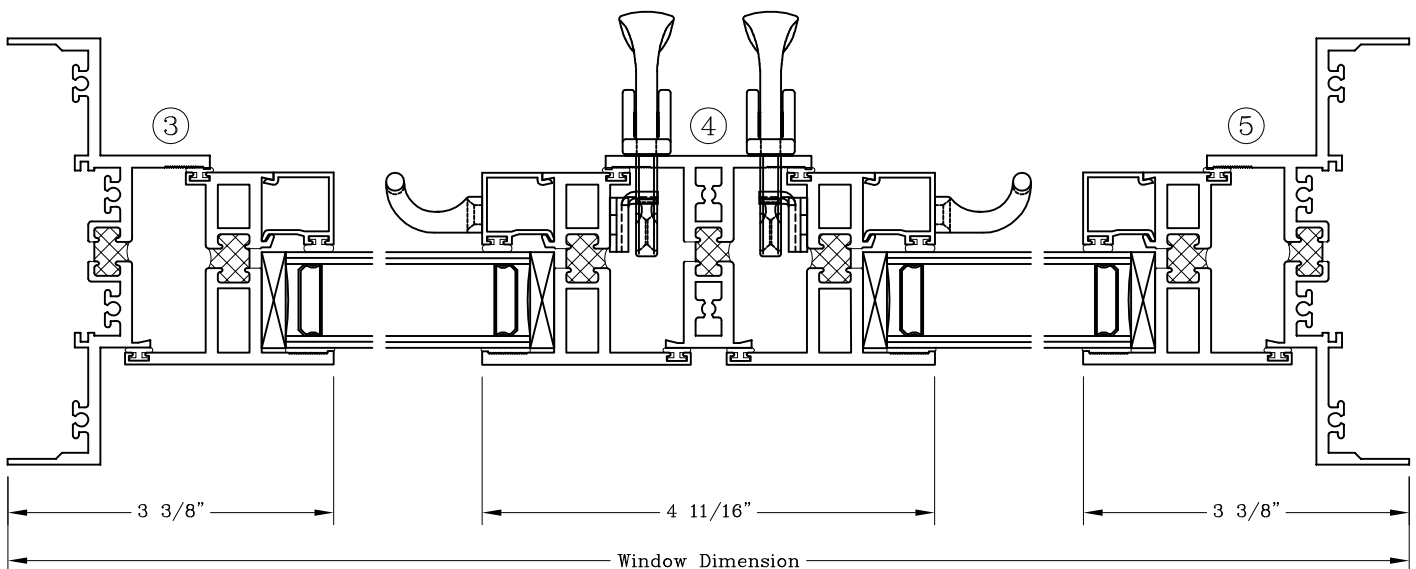

Note: Dashed Lines Represent Inswing Vented Units Solid Lines Represent
Outswing Vented Units; Lines Converge At Hinge Side Of Vent