

Graham

Casement - 3 1/2"

C-AW70



Architectural Products

Series: 6800

Manufacturing Code: 6804

Drawing 1/2 Scale - For Custom Size Drawing Contact Graham

Note: Sealant Not Shown On Details. Consult Technical Services At Factory For Sealing Procedures.

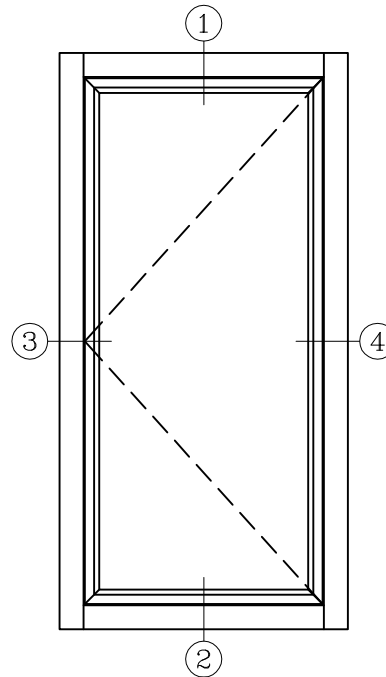
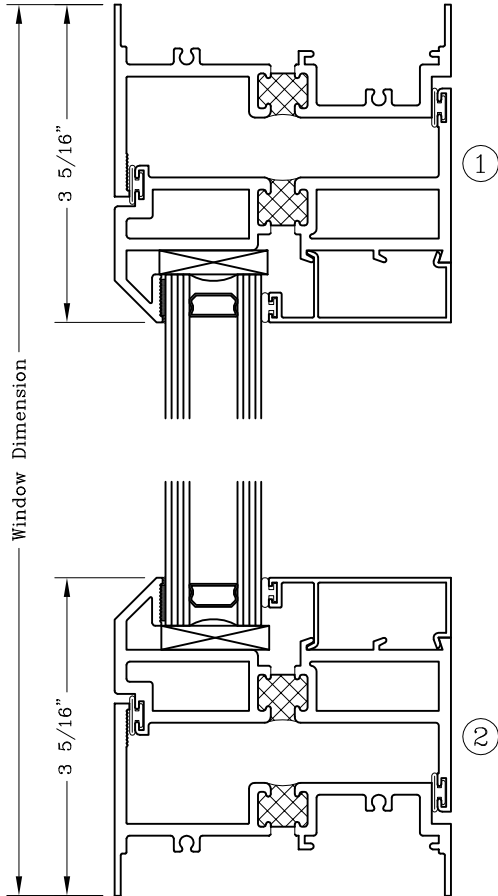

ELEVATION

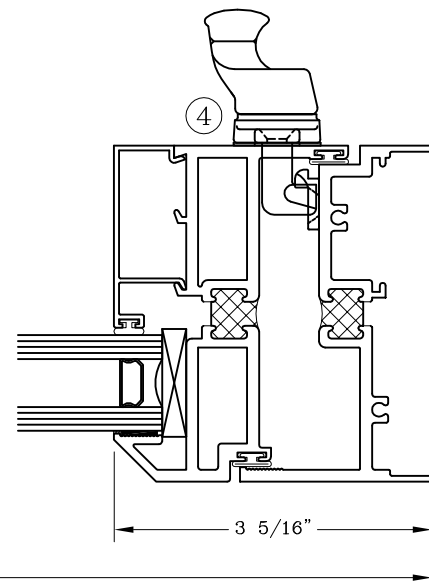
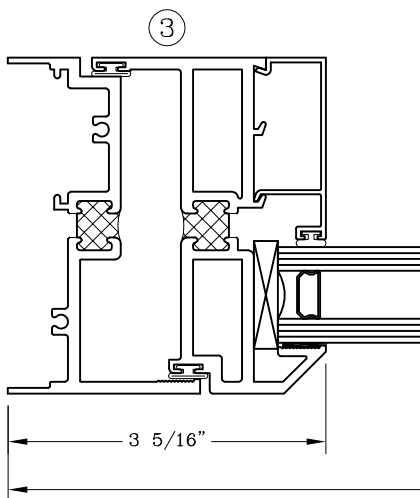

Note: Dashed Lines Represent Inswing Vented Units Solid Lines Represent Outswing Vented Units; Lines Converge At Hinge Side Of Vent