

Graham



Architectural Products

Projected/Projected - 2" AP-HC80

Series: 6100

Manufacturing Code: 6104

Drawing 1/2 Scale - For Custom Size Drawing Contact Graham

Note: Sealant Not Shown On Details. Consult Technical Services At Factory For Sealing Procedures.

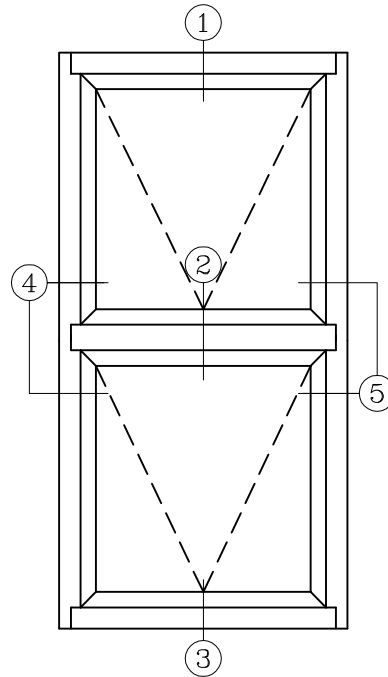
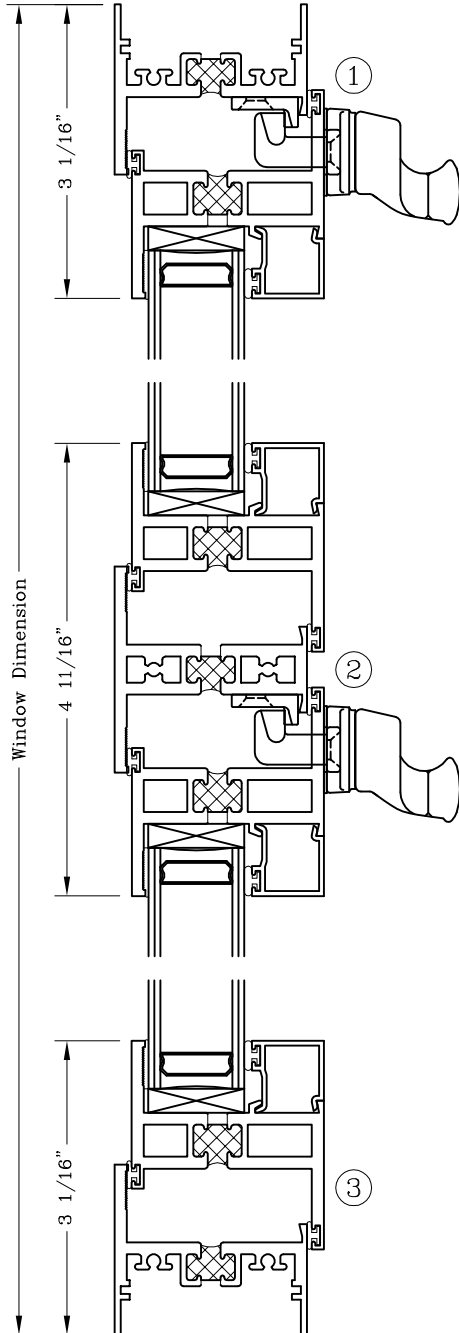

ELEVATION

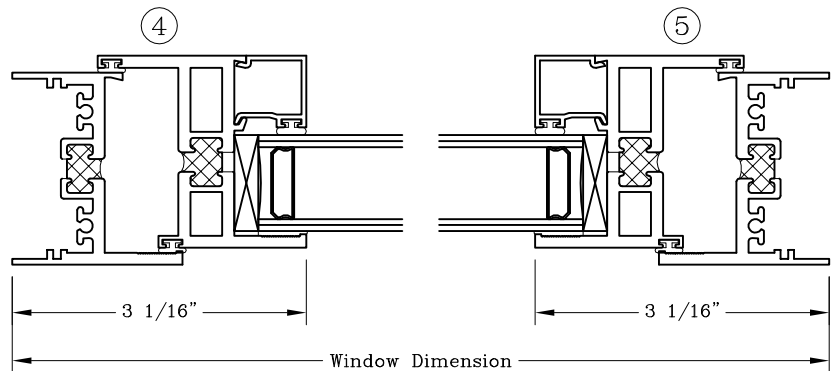

Note: Dashed Lines Represent Inswing Vented Units Solid Lines Represent
Outswing Vented Units; Lines Converge At Hinge Side Of Vent