

Graham



Architectural Products

Projected/Projected - 3 1/4"

AP-HC60

Series: 6000

Manufacturing Code: 6009

Drawing 1/2 Scale - For Custom Size Drawing Contact Graham

Note: Sealant Not Shown On Details. Consult Technical Services At Factory For Sealing Procedures.

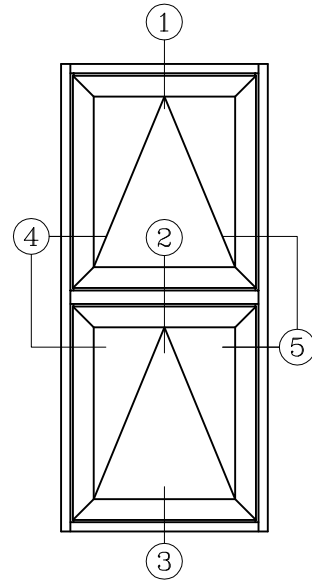
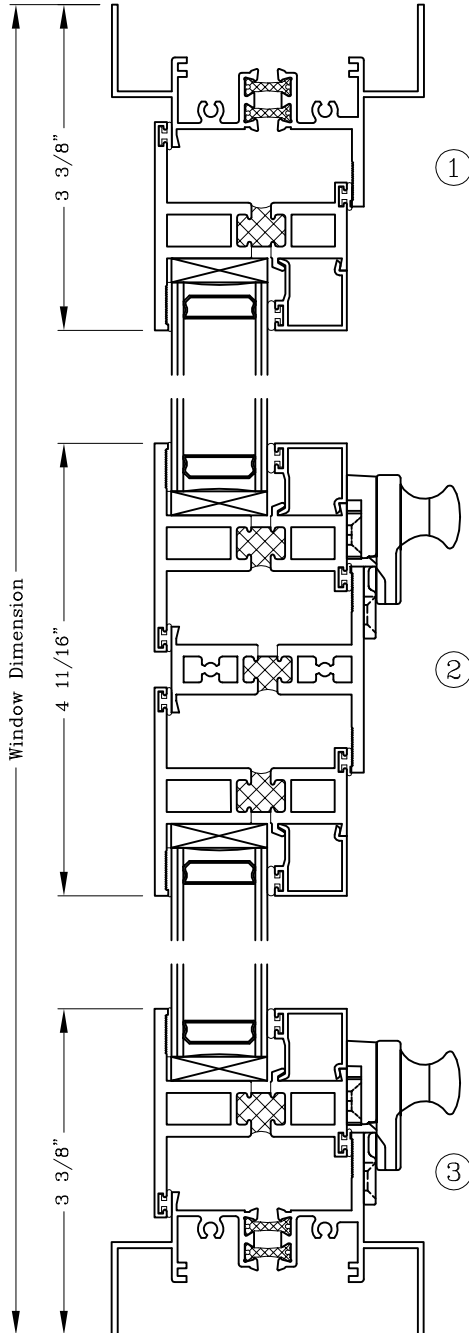

ELEVATION

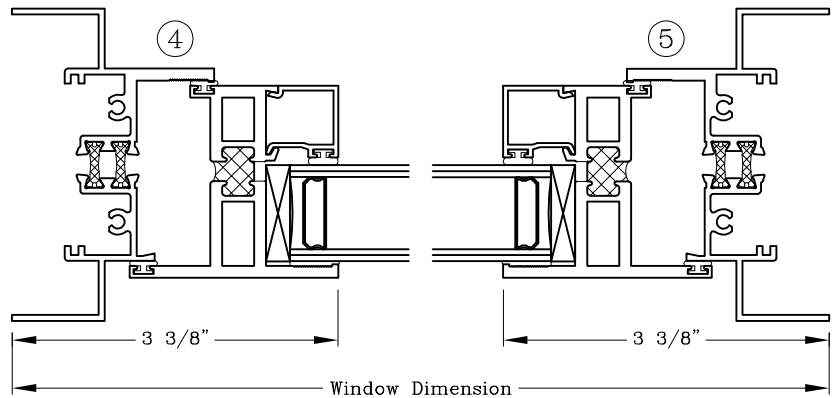

Note: Dashed Lines Represent Inswing Vented Units Solid Lines Represent Outswing Vented Units; Lines Converge At Hinge Side Of Vent