

Graham

Sliding Glass Door - 4"

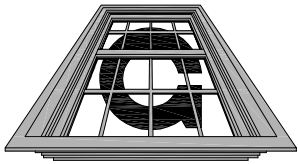

Architectural Products

Series: 0800

Manufacturing Code: 0806

Drawing 1/2 Scale - For Custom Size Drawing Contact Graham

Note: Sealant Not Shown On Details. Consult Technical Services At Factory For Sealing Procedures.

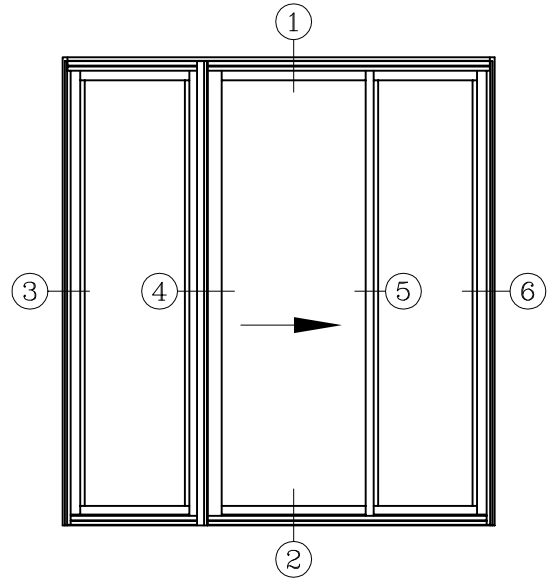
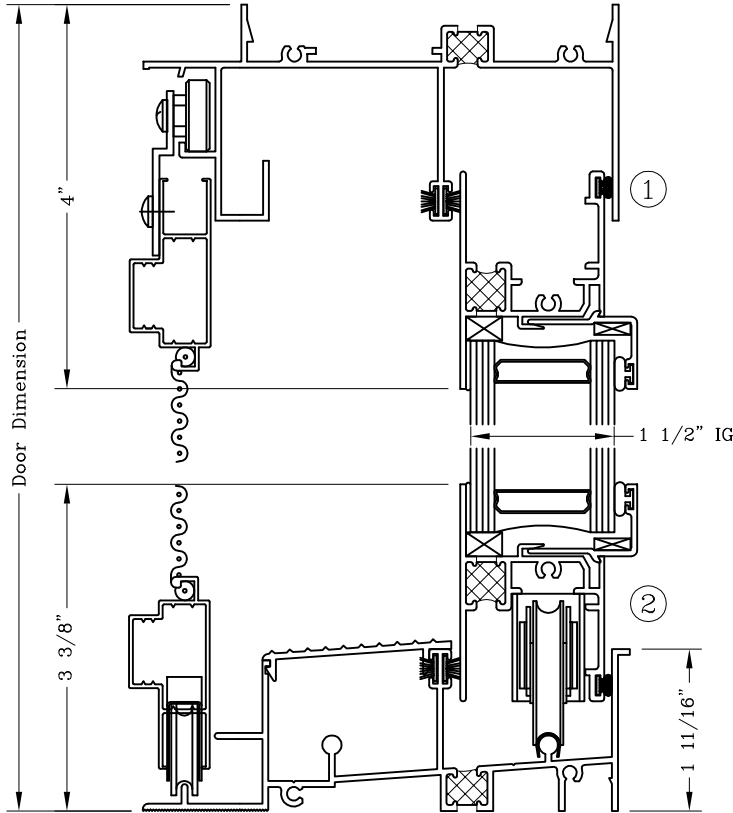

ELEVATION
OXO - Shown

Note:
Vertical Sections below 1/4 Scale.

